



# ROHINI

COLLEGE OF ENGINEERING & TECHNOLOGY

Approved by AICTE and Affiliated to Anna University, (An ISO Certified Institution)



## ME 8792 POWER PLANT ENGINEERING

DEPARTMENT OF  
**MECHANICAL ENGINEERING**

**ROHINI COLLEGE OF ENGINEERING AND TECHNOLOGY**

**DEPARTMENT OF MECHANICAL ENGINEERING**

**ME6701 POWER PLANT ENGINEERING**

**LECTURE NOTES**

## UNIT-I COAL BASED THERMAL POWER PLANTS

*Rankine cycle-improvisations, Layout of modern coal power plant, Super critical boiler FBC boilers, Turbines, condensers, Steam and heat rate, subsystems of thermal power plants- Fuel and ash handling, draught system, Feed water treatment, Binary cycles and cogeneration systems.*

### RANKINE CYCLE-IMPROVISATIONS

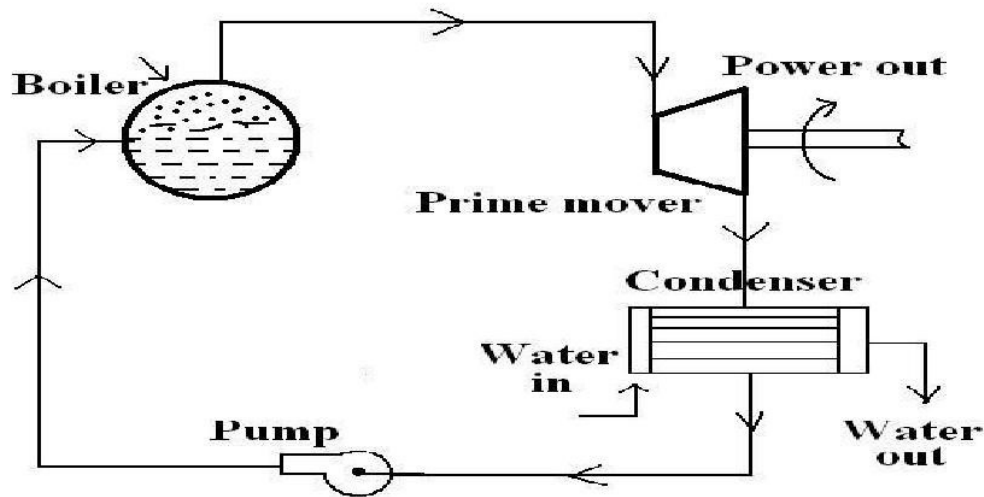

Fig.1 The arrangement of the components used for steam power plant working on rankine cycle.

The line diagram of the power plant working on Rankine cycle is shown in Fig 1. The rankine cycle used for steam power plant is shown in Fig. 2 and Fig 3 on P-V and T-S diagrams.

The different processes of the Rankine cycle are described below:

- (1) The point 'd' represents the water at condenser pressure  $P_2$  and corresponding saturation temperature  $T_2$ . The process 'de' represents the adiabatic compression of water by the pump from pressure  $P_2$  (condenser pressure) to pressure  $P_1$  (boiler pressure). There is slight rise in temperature of water during the compression process 'de'.
- (2) During the processes 'ea' and 'ab', heat is supplied by the boiler to the water to convert into steam. The process 'ea' represents the supply of heat at constant

pressure till the saturation temperature of water is reached corresponding to boiler pressure  $P_1$ . The point's e and a are same on PV diagram as increase in volume of water during this heating process is negligible. The process 'ab' represents the addition of heat to the water at constant pressure till the water completely converted into steam. The final condition of steam 'b' may be wet, dry saturated or superheated depending upon the quantity of heat supplied by the boiler.

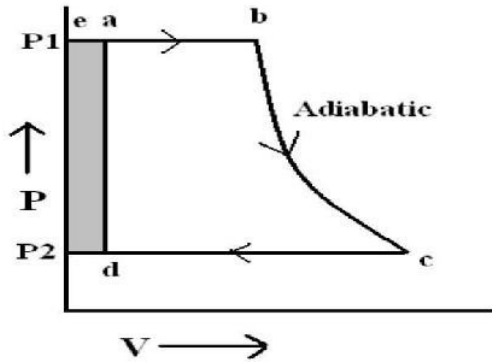

Fig 2. Rankine cycle On P-V diagram

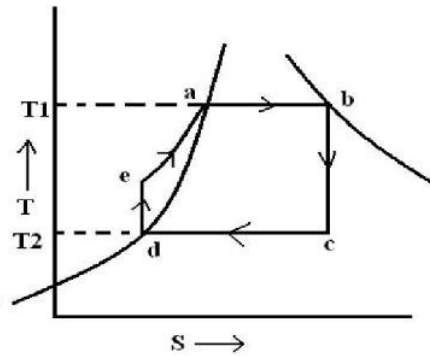

Fig 3. Rankine cycle on T-S diagram

- (3) The process 'bc' represents the isentropic expansion of steam in the prime mover as shown in Fig.3. During this expansion, external work is developed and the pressure of steam falls from  $P_1$  and  $P_2$  and its temperature will be  $T_2$ .
- (4) The process 'cd' represents the condensation of steam coming out from the prime mover in the condenser. During the condensation of steam, the pressure is constant and there is only change of phase from steam to water as the latent heat of steam ( $x_2 h_{fg2}$ ) is carried by circulating water in the condenser.
- (5) Again the process 'de' represents the adiabatic compression of water by the pump from the pressure  $P_2$  to  $P_1$  and the cycle is repeated

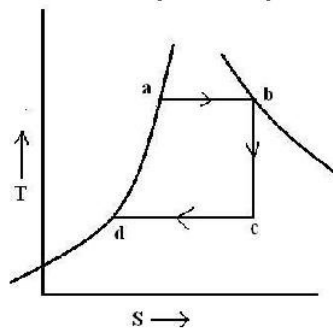

Fig.4 Rankine cycle neglecting pump



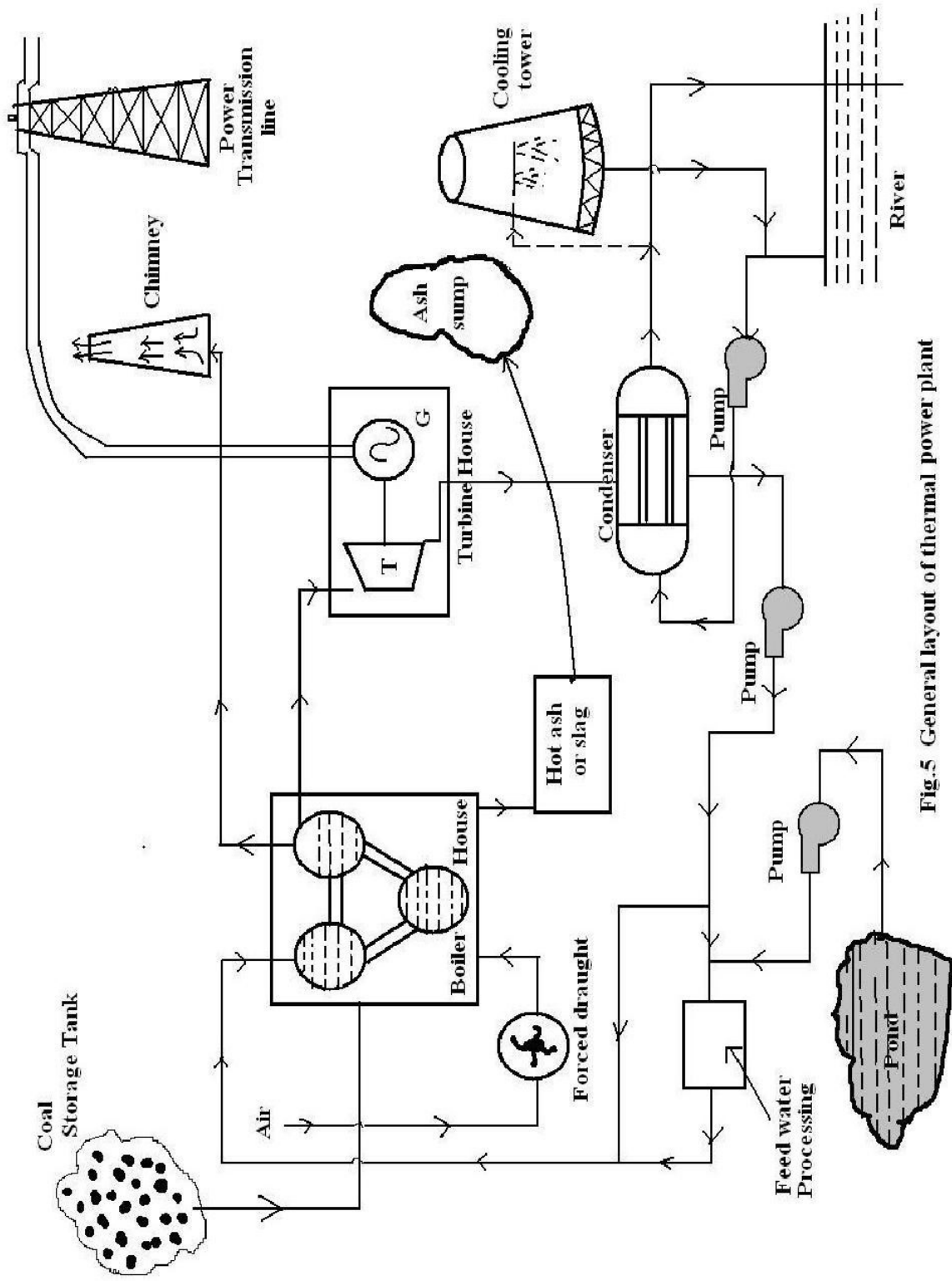

Fig.5 General layout of thermal power plant

10,11,12) Introduction

The development of power in any country depends upon the available resources in that country. The hydel power totally depends upon the natural sites available and hydrological cycle in that country. New sites cannot be humanly created for hydel power plants.

The development of nuclear power in a country requires advanced technological developments and fuel resources. This source of power generation is not much desirable for the developing countries as it is dependent on high technology and they are highly capital based systems.

Many times, hydel power suffers if draught comes even once during a decade and the complete progress of the nation stops. The calamity of rain draught on power industry has been experienced by many states of this country.

To overcome this difficulty, it is absolutely necessary to develop thermal plants in the country which are very much suitable for base load plants.

The general layout of the thermal power plant consists of mainly four circuits as shown in Fig.5 the four main circuits are:

1. Coal and ash circuit
  2. Air and gas circuit
  3. Feed water and steam flow circuit
  4. Cooling water circuit.
1. Coal and ash circuit

In this circuit, the coal from the storage is fed to the boiler through coal handling equipment for the generation of steam. Ash produced due to the combustion of coal is removed to ash storage through ash-handling system.

2. Air and Gas circuit

Air is supplied to the combustion chamber of the boiler either through F.D or I.D or by using both. The dust from the air is removed before supplying to the combustion chamber.

The exhaust gases carrying sufficient quantity of heat and ash are passed through the air-heater where the exhaust heat of the gases is given to the air and then it is passed through the dust collectors where most of the dust is removed before exhausting the gases to the atmosphere through chimney.

3. Feed water and Steam circuit

The steam generated in the boiler is fed to the steam prime mover to develop the power. The steam coming out of prime mover is condensed in the condenser and then fed to the boiler with the help of the pump.

The condensate is heated in the feed-heaters using the steam tapped from different points of the turbine. The feed heaters may be of mixed type or indirect heating type.

Some of the steam and water is lost passing through different components of the system; therefore, feed water is supplied from external source to compensate this loss. The feed water supplied from external sourced is passed through the purifying plant to reduce the dissolved salts to an acceptable level. The purification is necessary to avoid the scaling of the boiler tubes.

#### 4. Cooling water circuit

The quantity of cooling water required to condense the steam is considerably large and it is taken either from lake, river or sea. The cooling water is taken from the upper side of the river, it is passed through the condenser and heated water is discharged to the lower side of the river. Such system of cooling water supply is possible if adequate cooling water is available throughout the year. This system is known as open system.

When the adequate water is not available, then the water coming out from the condenser is cooled either in cooling pond or cooling tower. The cooling is effected by partly evaporating the water. This evaporative loss is nearly 2 to 5% of the cooling water circulated in the system.

To compensate the evaporative loss, the water from the river is continuously supplied. When the cooling water coming out of the condenser is cooled again and supplied to the condenser is cooled again and supplied to the condenser then the system is known as closed system.

When the water coming out from the condenser is discharged to river downward side directly, the system is known as open system. Open system is economical than closed system provided adequate water is available throughout the year.

#### Working of the thermal power

Steam is generated in the boiler of thermal power plant using the heat of the fuel burned in the combustion chamber. The steam generated is passed through steam turbine where part of its thermal energy is converted into mechanical energy which is further used for generating electric power.

#### Merits:

- (i) Higher efficiency
- (ii) Lower cost
- (iii) Ability to burn coal especially of high ash content, and inferior coals.
- (iv) Reduced environmental impact in terms of air pollution
- (v) Reduced water requirement
- (vi) Higher reliability and availability

Demerits:

- (i) There are more chances of explosion as coal burns like a gas
- (ii) Coal transportation is quite complicated.

## **SUPER CRITICAL BOILERS**

The increasing fuel costs with decreasing fuel quantity have constantly persuaded power engineers to search for more economical methods of power generation. The most recent method to produce economical thermal power is by the use of super-critical steam cycle.

Between the working ranges of 125 bar and 510°C to 300 bar and 600°C, large numbers of steam generating units are designed which are basically characterized as sub-critical and super-critical. Usually a sub-critical boiler consists of three distinct sections as preheater (economizer), evaporator and superheater and in case of super-critical boiler, the only preheated and superheaters are required.

The structural layouts of both types of boilers otherwise practically identical. With the recent experiments gained in design and construction of super-critical boilers, it has become a rule to use super-critical boilers above 300 MW capacity units.

The **advantages** of supercritical boilers over critical types are listed below:

- (1) The heat transfer rates are considerably large compared with sub-critical boilers. The steam side heat transfer coefficient for sub-critical is  $16500 \text{ kJ/m}^2 \text{-hr}^\circ\text{C}$  when the steam pressure and temperature are 180 bar and 538°C whereas the steam side heat transfer, coefficient for super-critical boiler is  $220000 \text{ kJ/m}^2 \text{hr-}^\circ\text{C}$  when the steam is generated at 240°C.
- (2) The pressure level is more stable due to less heat capacity of the generator and therefore gives better response.
- (3) Higher thermal efficiency (40-42%) of power station can be achieved with the use of super critical steam.
- (4) The problems of erosion and corrosion are minimized in super-critical boilers as two phase mixture does not exist.
- (5) The turbo generators connected to super critical boilers can generate peak loads by changing the pressure of operation.
- (6) There is a great ease of operation and their comparative simplicity and flexibility make them adaptable at load fluctuations.

## FBC BOILERS

Fluidized bed boilers produce steam from fossil and waste fuels by using a technique called fluidized bed combustion. These can be of two types:

1. Bubbling fluidized bed (BFB) boilers
2. Circulating fluidized bed (CFB) boilers

### Bubbling fluidized bed (BFB) boilers

In BFB boilers, crushed coal (6-20mm) is injected into the fluidized bed of limestone just above an air-distribution grid at the bottom of the bed (Fig.6)

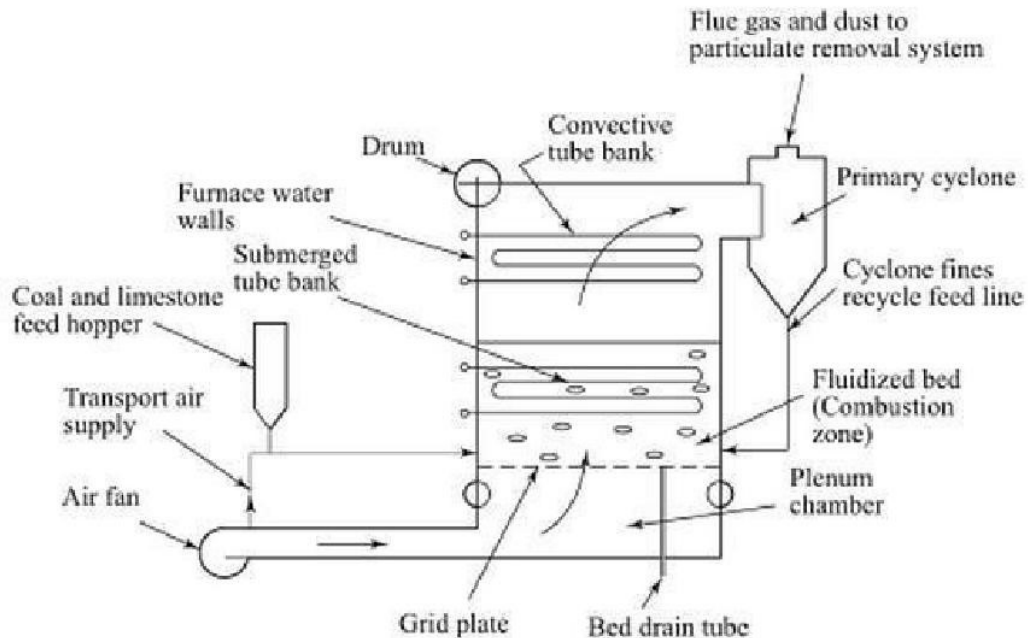

Fig.6 Schematic of bubbling fluidized bed boiler

The air flows upwards through the grid from the air plenum into the bed, where combustion of coal occurs. The products of combustion leaving the bed contain a large proportion of unburnt carbon particles which are collected in cyclone separator and fed back to the bed. The boiler water tubes are located in the furnace.

Since most of the sulphur in coal is retained in the bed by the material used (limestone), the gases can be cooled to a lower temperature before leaving the stack with less formation of acid ( $H_2SO_4$ ). As a result of low combustion temperatures ( $800-900^{\circ}C$ ), inferior gases of coal can be used without slagging problems and there is less formation of  $NO_x$ .

Cheaper alloy materials can be used, resulting in economy of construction. Further economies are achieved since no pulverizer is required. The volumetric heat release rates are 10 to 15 times higher and the surface heat transfer rates are 2 to 3 times higher than a conventional boiler. This makes the boiler make compact.

Fig.7 shows a bubbling bed boiler system operating at atmospheric pressure, similar to the one of 160 MWe Tennessee Valley Authority (TVA) project at Shawnee, USA, recently installed (1993).

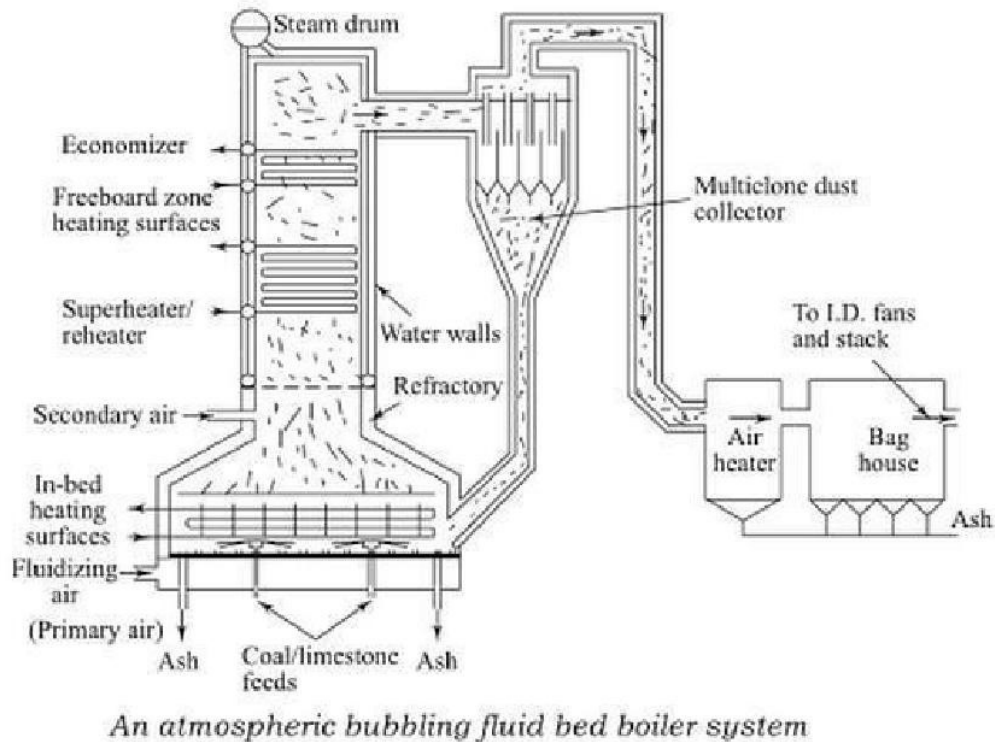

Fig.7

### **Circulating fluidized bed (CFB) boilers**

The CFB boiler is said to be the second generation fluidized bed boiler Fig.8. It is divided into two sections. The first section consists of

- (a) Furnace or fast fluidized bed
- (b) Gas-solid separator (cyclone)
- (c) Solid recycle device (loop seal or L-value)
- (d) External heat exchanger

These components form a solid circulation loop in which fuel is burned. The furnace enclosure of a CFB boiler is generally made of water tubes as in pulverized coal fired (PC)

boilers. A fraction of the generated heat is absorbed by these heat transferring tubes. The second section is the back-pass, where the remaining heat from the flue gas is absorbed by the reheater, economizer and air preheater surfaces (as in a conventional boiler)

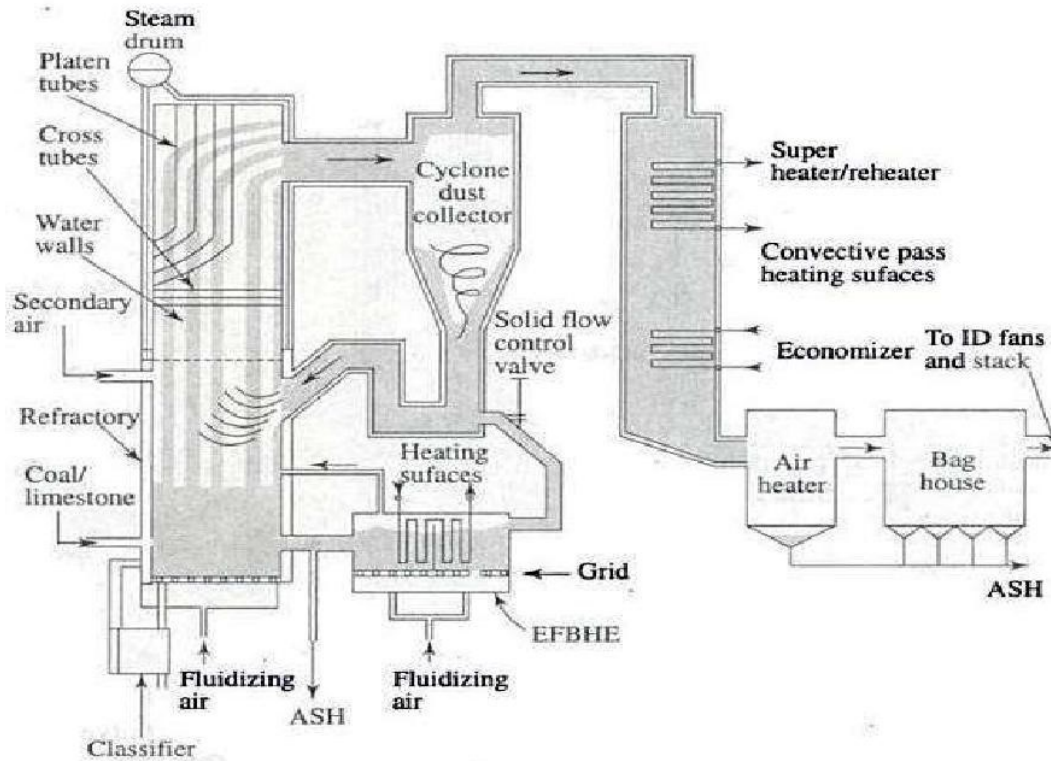

Fig.8 Schematic of a circulating fluidized bed boiler

The lower part of the first section (furnace) is often tapered. Its walls are lined with refractory up to the level of secondary air entry. Beyond this the furnace walls are generally cooled by evaporative, superheater, or reheater surfaces. The gas-solid separator and the non-mechanical valve are also lined with refractory. In some designs, a part of hot solids recycling between the cyclone and the furnace is diverted through an external heat exchanger, which is a bubbling fluidized bed with heat transfer surfaces immersed in it to remove heat from the hot solids.

Coal is generally injected into the lower section of the furnace. It is sometimes fed into the loop-seal, from which it enters the furnace along with returned solids. Limestone is fed into the bed in a similar manner. Coal burns when mixed with hot bed solids.

The primary combustion air enters the furnace through an air distributor or grate at the furnace floor. The secondary air is injected at some height above the grate to complete the

combustion. Bed solids are well mixed throughout the height of the furnace. Thus, the bed temperature is nearly uniform in the range 800-900°C, though heat is extracted along its height.

Relatively coarse particles of sorbent (limestone) and unburned char, larger than the cyclone cut-off size, are captured in the cyclone and are recycled back near the base of the furnace. Finer solid residues (ash and spent sorbents) generated during combustion and desulphurization leave the furnace, escaping through the cyclones, but they are collected by a bag-house or electrostatic precipitator located further downstream.

## **TURBINES**

Steam turbine is a heat engine which uses the heat energy stored in steam and performs work. The main parts of a steam turbine are as follows:

- (i) A rotor on the circumference of which a series of blades or buckets are attached. To a great extent of performance of the turbine depends upon the design and construction of blades.

The blades should be so designed that they are able to withstand the action of steam and the centrifugal force caused by high speed.

As the steam pressure drops the length and size of blades should be increased in order to accommodate the increase in volume. The various materials used for the construction of blades materials used for the construction of blades depend upon the conditions under which they operated steel or alloys are the materials generally used.

- (ii) Bearing to support the shaft.
- (iii) Metallic casing which surrounds blades, nozzles, rotor etc.
- (iv) Governor to control the speed.
- (v) Lubricating oil system.

Steam from nozzles is directed against blades thus causing the rotation. The steam attains high velocity during its expansion in nozzles and this velocity energy of the steam is converted into mechanical energy by the turbine.

As a thermal prime mover, the thermal efficiency of turbine is the usual work energy appearing as shaft power presented as a percentage of the heat energy available.

High pressure steam is sent in through the throttle valve of the turbine. From it comes torque energy at the shaft, exhaust steam, extracted steam, mechanical friction and radiation.

Depending upon the methods of using steam arrangement and construction of blades, nozzle and steam passages, the steam turbines can be classified as follows:

1. According to the action of steam
  - (i) Impulse turbine
  - (ii) Reaction turbine

(iii) Impulse and reaction turbine.

In impulse turbine (Fig.9) the steam expands in the stationary nozzles and attains high velocity. The resulting high velocity steam impinges against the blades which alter the direction of steam jet thus changing the momentum of jet and causing impulsive force on the blades.

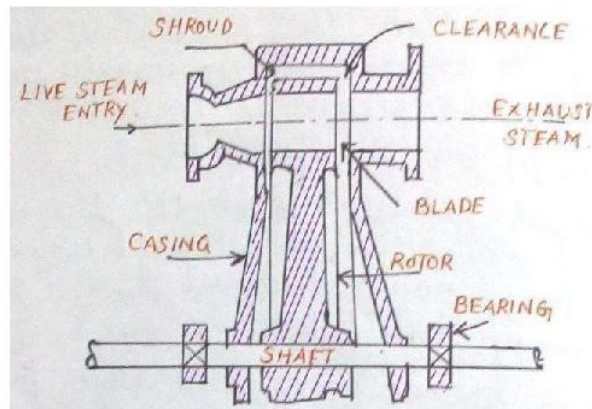

Fig.9 Impulse Turbine

In reaction turbine steam enters the fast moving blades on the rotor from stationary nozzles. Further expansion of steam through nozzles shaped blades changes the momentum of steam and causes a reaction force on the blades.

Commercial turbines make use of combination of impulse and reaction forces because steam can be used efficiently by using the impulse and reaction blading on the same shaft. Fig.10 shows impulsed reaction turbine.

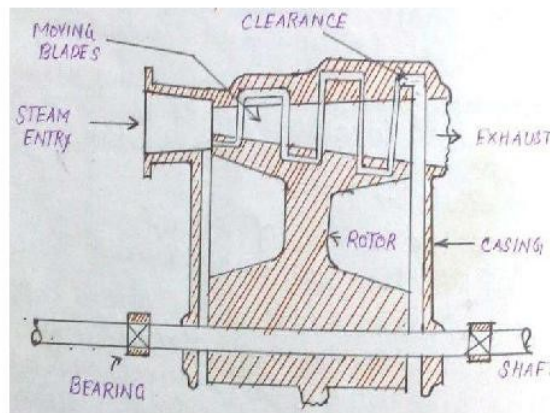

Fig.10 Reaction Turbine

2. According to the direction of steam flow
  - (i) Axial
  - (ii) Radial

- (iii) Mixed
- 3. According to pressure of exhaust
  - (i) Condensing
  - (ii) Non-condensing
  - (iii) Bleeder
- 4. According to pressure of entering steam
  - (i) Low pressure
  - (ii) High pressure
  - (iii) Mixed pressure
- 5. According to step reduction
  - (i) Single stage
  - (ii) Multi-stage
- 6. According to method of drive such as
  - (i) Direct connected
  - (ii) Geared

## CONDENSERS

The thermal efficiency of a closed cycle power developing system using steam as working fluid and working on carnot cycle is given by an expression  $(T_1 - T_2)/T_1$ . This expression of efficiency shows that the efficiency increases with an increase in temperature  $T_1$  and decrease in temperature  $T_2$ .

The maximum temperature  $T_2$ (temperature at which heat is rejected) can be reduced to the atmospheric temperature if the exhaust of the steam takes place below atmospheric pressure. If the exhaust is at atmospheric pressure, the heat rejection is at  $100^\circ\text{C}$ .

Low exhaust pressure is necessary to obtain low exhaust temperature. But the steam cannot be exhausted to the atmosphere if it is expanded in the engine or turbine to a pressure lower than the atmospheric pressure. Under this condition, the steam is exhausted into a vessel known as condenser where the pressure is maintained below the atmosphere by continuously condensing the steam by means of circulating cold water at atmospheric temperature.

*A closed vessel in which steam is condensed by abstracting the heat and where the pressure is maintained below atmospheric pressure is known as a condenser.* The efficiency of the steam plant is considerably increased by the use of a condenser. In large turbine plants, the condensate recovery becomes very important and this is also made possible by the use of condenser.

The steam condenser is one of the essential components of all modern steam power plants. Steam condensers are of two types:

1. Surface condenser

- (a) Down flow type
  - (b) Central flow condenser
  - (c) Evaporation condenser
2. Jet condenser
- (a) Low level jet condensers (parallel flow type)
  - (b) High level or barometric condenser
  - (c) Ejector condenser

**Surface condensers**

In surface condensers there is no direct contact between the steam and cooling water and the condensate can be re-used in the boiler. In such condenser even impure water can be used for cooling purpose whereas the cooling water must be pure in jet condensers. Although the capital cost and the space needed is more in surface condensers but it is justified by the saving in running cost and increase in efficiency of plant achieved by using this condenser. Depending upon the position of condensate extraction pump, flow of condensate and arrangement of tubes the surface condensers may be classified as follows:

- (a) Down flow type

Fig.11(a) shows a sectional view of down flow condenser. Steam enters at the top and flows downward. The water flowing through the tubes in one direction lower half comes out in the opposite direction in the upper half. Fig.11(b) shows a longitudinal section of a two pass down-flow condenser.

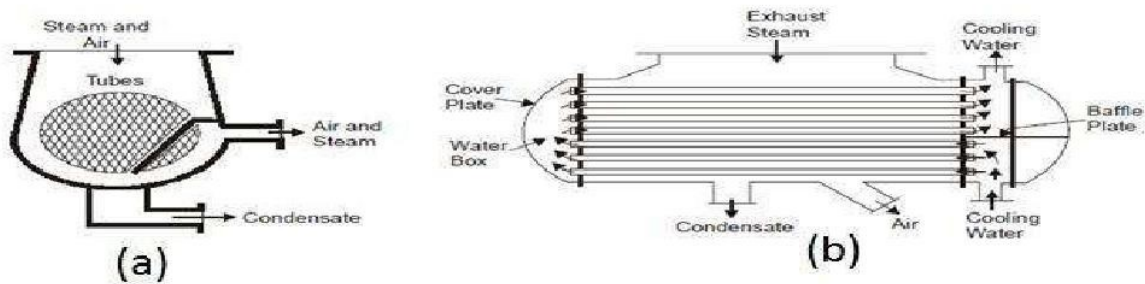

Fig.11

- (b) Central flow condenser

Fig.12 shows a central flow condenser. all around the periphery of the shell. Air is condensed.

In this condenser the steam passages are pumped away from the center of the

The condensate moves radially towards the center of tube nest. Some of the exhaust steam which moves towards the center meets the undercooling condensate and pre-heats it thus reducing under cooling.

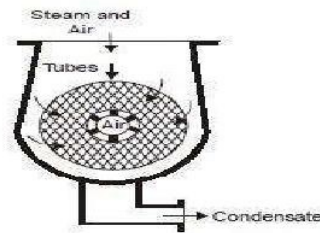

Fig.12

(c) Evaporation condenser.

In this condenser Fig.13 steam to be condensed is passed through a series of tubes and the cooling water falls over these tube in the form of spray. A stream of air flows over the tubes to increase evaporation of cooling water which further increases the condensation of steam.

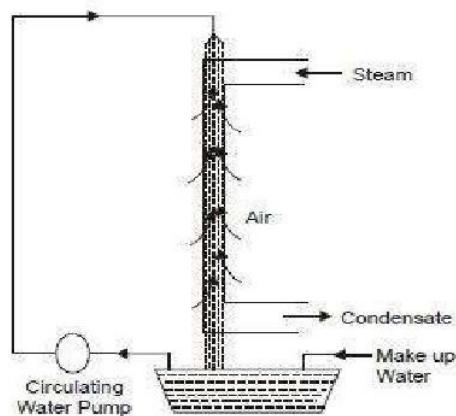

Fig.13 Evaporation condenser

Advantages

- (i) The condensate can be used as boiler feed water.
- (ii) Cooling water of even poor quality can be used because the cooling water does not come in direct contact with steam.
- (iii) High vacuum (about 73.5 of Hg) can be obtained in the surface condenser. This increasing the thermal efficiency of the plant.

Disadvantages

- (i) The capital cost is more
- (ii) The maintenance cost and running cost this condenser is high
- (iii) It is bulky and requires more space.

**Jet condensers**

In jet condensers the exhaust steam and cooling water come in direct contact with each other. The temperature of cooling water and the condensate is same when leaving the condensers.

Elements of the jet condenser are as follows:

- (i) Nozzles or distributors for the condensing water.
- (ii) Steam inlet
- (iii) Mixing chambers: They may be (a) Parallel flow type (b) Counter flow type depending on whether the steam and water move in the same direction before condensation or whether the flows are opposite
- (iv) Hot well

In jet condensers the condensing water is called injection water.

**(a) Low level jet condensers (Parallel flow type)**

In this condenser Fig.14 water is sprayed through jets and it mixes with steam. The air is removed at the top by an air pump.

In counter flow type of condenser the cooling water flows in the downward direction and the steam to be condensed moves upward.

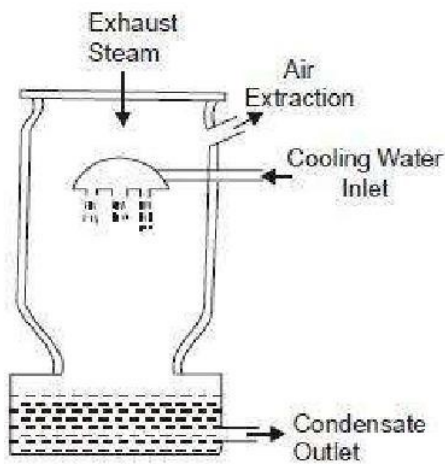

**Fig.14**

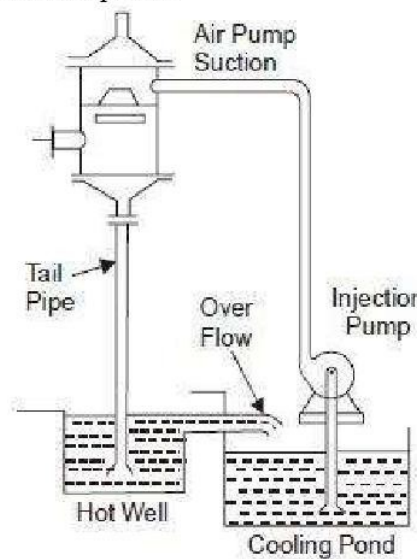

**Fig.15**

**Low level and high level jet condenser**

(b) High level or Barometric condenser

Fig.15 shows a high level jet condenser. The condenser shell is placed at a height of 10.33m (barometric height) above the hot well. As compared to low level jet condenser this condenser does not flood the engine if the water extraction pumps fail. A separate air pump is used to remove the air.

(c) Ejector condenser

Fig.16 shows an ejector condenser. In this condenser cold water is discharged under a head of about 5 to 6m through a series of convergent nozzles. The steam and air enter the condenser through a non-return valve.

Steam gets condensed by mixing with water. Pressure energy is partly converted into kinetic energy at the converging cones. In the diverging cone the kinetic energy is partly converted into pressure energy and a pressure higher than atmospheric pressure is achieved so as to discharge the condensate to the hot well.

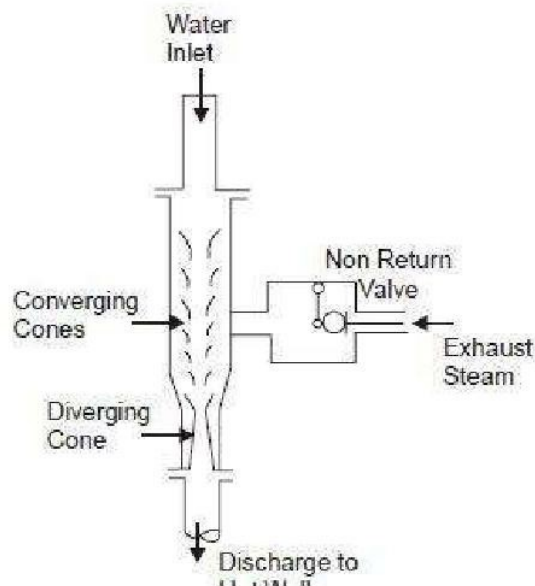

Fig.16 Ejector condenser

## FUEL HANDLING SYSTEM (COAL HANDLING)

Coal delivery equipment is one of the major components of plant cost. The various steps involved in coal handling are as follows:

1. Coal Delivery

The coal from supply points is delivered by ships or boats to power stations situated near to sea or river whereas coal is supplied by rail or trucks to the power stations which are situated away from sea or river.

## 2. Unloading

The type of equipment to be used for unloading the coal received at the power station depends on how coal is received at the power station. If coal is delivered by trucks, there is no need of unloading device as the trucks may dump the coal to the outdoor storage. Coal is easily handled if the lift trucks with scoop are used.

In case the coal is brought by railway wagons, ships or boats, the unloading may be done by car shakes, rotary car dumpers, cranes, grab buckets and coal accelerators. Rotary car dumpers although costly are quite efficient for unloading closed wagons.

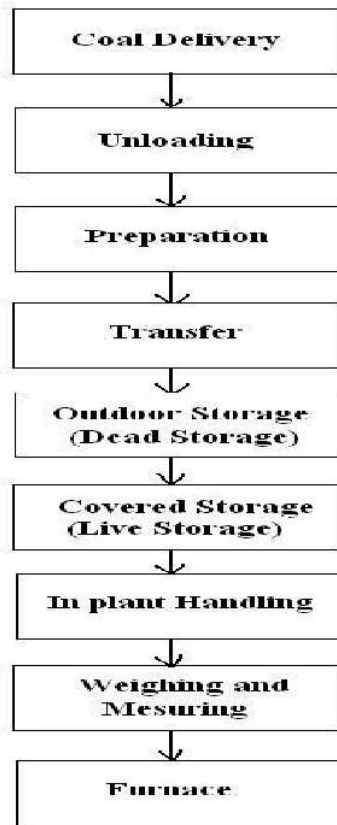

Fig.17 Steps in coal Handling

## 3. Preparation

When the coal delivered is in the form of big lumps and it is not of proper size, the preparation (sizing) of coal can be achieved by crushers, breakers, sizers driers and magnetic separators.

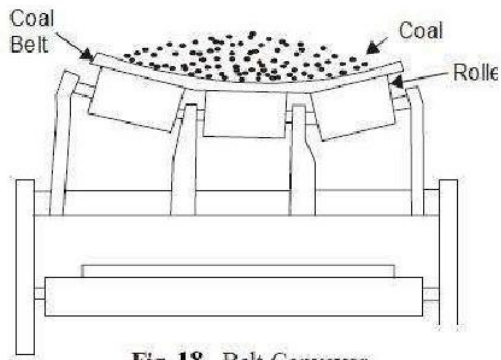

Fig. 18 . Belt Conveyor.

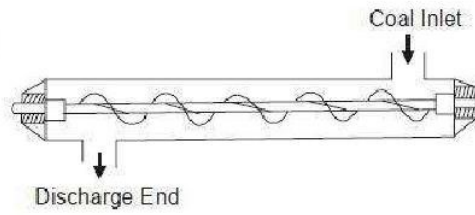

Fig. 19 Screw Conveyor.

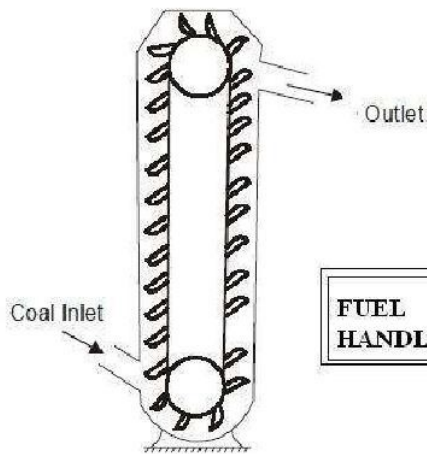

Fig. 20 Bucket Elevator.

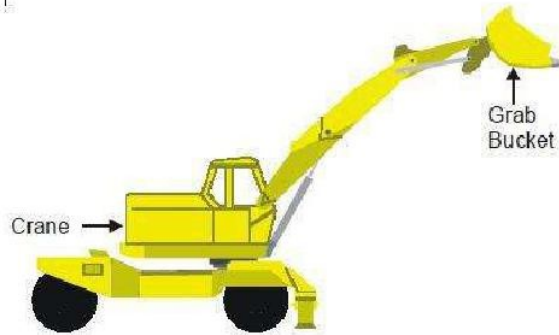

Fig. 21 Grab Bucket Elevator.

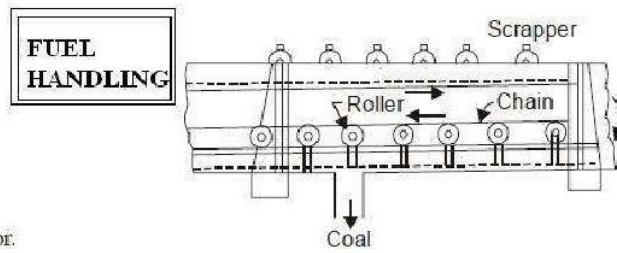

Fig. 23 . Flight Conveyor.

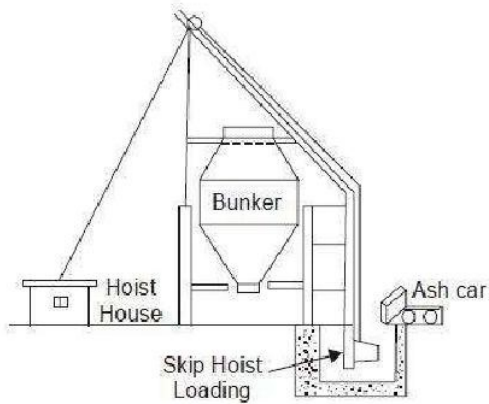

Fig. 22 Skip Hoist.

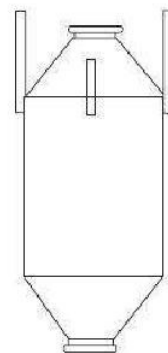

Fig. 24 Cylindrical Bucket

#### 4. Transfer

After preparation of coal is transferred to the dead storage by means of the following systems:

- (a) Belt conveyors
- (b) Screw conveyors
- (c) Bucket elevators
- (d) Grab bucket elevators
- (e) Skip hoists
- (f) Flight conveyor

##### (a) Belt conveyor

Fig.18 shows a belt conveyor. It consists of an endless belt moving over a pair of end drums(rollers). At some distance a supporting roller is provided at the center.

The belt is made up of rubber or canvas. Belt conveyor is suitable for the transfer of coal over long distances. It is used in medium and large power plants. The initial cost of the system is not high and power consumption is also low.

The inclination at which coal can be successfully elevated by belt conveyor is about 20. Average speed of belt conveyor varies between 200-300 rpm. This conveyor is preferred than other types.

Advantages of belt conveyor:

- (1) Its operation is smooth and clean
- (2) It requires less power as compared to other types of systems.
- (3) Large quantities of coal can be discharged quickly and continuously.
- (4) Material can be transported on moderate inclines

##### (b) Screw Conveyor

It consists of an endless helicoids screw fitted to a shaft (Fig.19) The screw while rotating in a trough transfers the coal from feeding end to the discharge end.

This system is suitable, where coal is to be transferred over shorter distance and space limitations exist. The initial cost of the system is low. It suffers from the drawbacks that the power consumption is high and there is considerable wear of screw. Rotation of screw varies between 75-125 r.p.m.

##### (c) Bucket elevator

It consists of buckets fixed to a chain Fig.20. The chain moves over two wheels.

The coal discharged at the top.

##### (d) Grab bucket elevator

It lifts and transfers coal on a single rail or track from one point to the other. The coal lifted by grab buckets is transferred to overhead bunker or storage. This system requires less power for operation and requires minimum maintenance.

The grab bucket conveyor can be used with crane or tower as shown in Fig.21 Although the initial cost of this system is high but operating cost is less.

(e) Skip hoist

It consists of a vertical or inclined hoist way a bucket or a car guided by a frame and cable for hoisting the bucket. It is simple and compact method of elevating coal or ash Fig.22 shows a skip hoist.

(f) Flight Conveyor

It consists of one or two strands of chain to which steel scrapes or flights are attached, which scrap the coal through a trough having identical shape. This coal is discharged in the bottom of trough. It is low in first cost but has large energy consumption. There is considerable wear.

Skip hoist and bucket elevators lift the coal vertically while belts and flight conveyors move the coal horizontally or on inclines.

Fig. 23 shows a flight conveyor. Flight conveyors possess the following **advantages**

- (i) They can be used to transfer coal as well as ash.
- (ii) The speed of conveyor can be regulated easily.
- (iii) They have a rugged construction
- (iv) They need little operational care.

**Disadvantages:**

- (i) There is more wear due to dragging action.
- (ii) Power consumption is more
- (iii) Maintenance cost is high
- (iv) Due to abrasive nature of material handle the speed of conveyors is low (10 to 30m/min).

5. Storage of coal

It is desirable that sufficient quantity of coal should be stored. Storage of coal gives protection against the interruption of coal supplies when there is delay in transportation of coal or due to strikes in coal mines.

Also when the prices are low, the coal can be purchased and stored for future use. The amount of coal to be stored depends on the availability of space for storage, transportation facilities, the amount of coal that will be shipped away and nearness to coal mines of the power station.

Usually coal required for month operation of power plant is stored in case of power stations situated at longer distance from the collieries whereas coal need for about 15 days is stored in case of power station situated near to collieries. Storage of coal for longer periods is not advantageous because it blocks the capital and results in deterioration of the quality of coal.

The coal received at the power station is stored in dead storage in the form of piles laid directly on the ground.

The coal stored has the tendency to whether (to combine with oxygen of air) and during this process coal has some of its heating value and ignition quality. Due to low oxidization the coal may ignite spontaneously. This is avoided by storing coal in the form of piles which consists of thick and compact layers of coal so that air cannot pass through the coal piles. This will minimize the reaction between coal and oxygen.

The other alternative is to allow the air to pass through layers of coal so that air may remove the heat of reaction and avoid burning. In case the outer coal is to be stored for longer periods the outer surface of piles may be sealed with asphalt or fine coal.

The coal is stored by the following methods.

(i) Stocking the coal in heats

The coal is piled on the ground up to 10-12m height. The pile top should be given a slope in the direction in which the rain may be drained off.

The sealing of stored pile is desirable in order to avoid the oxidation of coal after packing an air tight layer of coal.

Asphalt, fine coal dust and bituminuous coating are the materials commonly used for this purpose.

(ii) Under water storage

The possibility of slow oxidation and spontaneous combustion can be completely eliminated by storing the coal under water.

Coal should be stored at a site located on solid ground, well drained, free of standing water preferably on high ground not subjected to flooding.

6. In plant Handling

From the dead storage the coal is brought to covered storage (live storage)(bins or bunkers). A cylindrical bunker shown in Fig.24. In plant handling may include the equipment such as belt conveyors, screw conveyors, bucket elevators etc., to transfer the coal. Weigh lorries, hoppers and automatic scales are used to record the quantity of coal delivered to the furnace.

7. Coal weighing methods

Weigh lorries, hoppers and automatic scales are used to weigh the quantity of coal. The commonly used methods to weigh the coal are as follows:

(i) Mechanical (ii) Pneumatic (iii) Electronics

The mechanical method works on a suitable lever system mounted on knife edges and bearing connected to a resistance in the form of a spring of pendulum.

The pneumatic weighters use a pneumatic transmitted weight head and the corresponding air pressure determined by the load applied.

The electronic weighing machines make use of load cells that produce voltage signals proportional to the load applied.

The important factors considered in selecting fuel handling surface systems are as follows:

- (i) Plant flue rate
- (ii) Plant location in respect to fuel shipping
- (iii) Storage area available

### ASH HANDLING SYSTEM

Boilers burning pulverized coal (PC) have dry bottom furnaces. The large ash particles are collected under the furnace in a water-filled ash hopper. Fly ash is collected in dust collectors with either an electrostatic precipitator or a bag house. A PC boiler generates approximately 80% fly ash and 20% bottom ash. Ash must be collected and transported from various points of the plants as shown in Fig.25. Pyrites, which are the rejects from the pulverizers, are disposed with the bottom ash systems. Three major factors should be considered for ash disposal systems.

- 1. Plant site
- 2. Fuel source
- 3. Environmental regulation

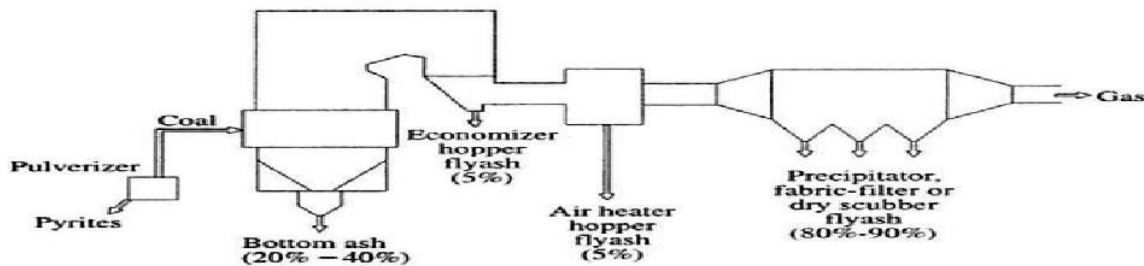

Fig.25 Ash collection and transportation

The sluice conveyor system (Fig. 26(a)) is the most widely used for bottom ash handling, while the hydraulic vacuum conveyor (Fig. 26(b)) is the most frequently used for fly ash systems.

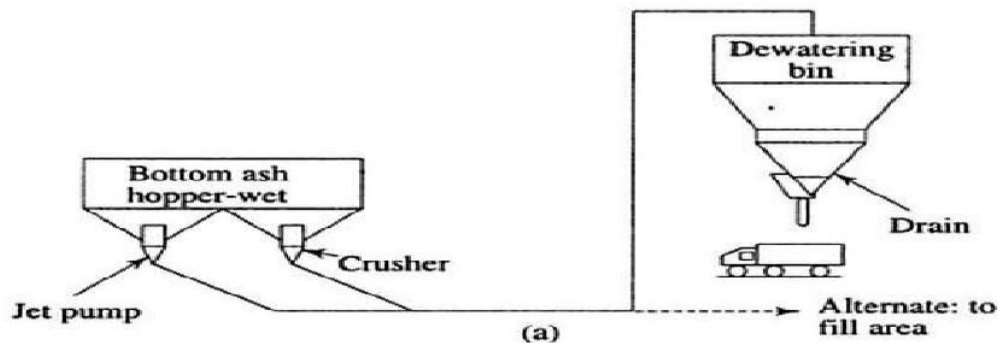

Fig. 26 (a) Bottom ash sluice conveyor, (b) fly ash hydraulic vacuum conveyor

Bottom ash and slag may be used as filling material for road construction. Fly ash can partly replace cement for making concrete. Bricks can be made with fly ash. These are durable and strong.

## **DRAUGHT SYSTEM**

The purpose of draught is as follows:

- (1) The supply required amount of air to the furnace for the combustion of fuel. The amount of fuel that can be burnt per square foot of grate area depends upon the quantity of air circulated through fuel bed.
- (2) To remove the gaseous products of combustion

### **Definition**

Draught is defined as the difference between absolute gas pressure at any point in a gas flow passage and the ambient (same elevation) atmospheric pressure.

Draught is plus is  $P_{atm} < P_{gas}$  and it is minus  $P_{atm} > P_{gas}$ . Draught is achieved by small pressure difference which causes the flow of air or gas to take place. It is measured in millimeter (mm) of water.

If only a chimney is used to create the necessary draught, the system is called natural draught system and if an addition to chimney a forced draught(F.D) fan or an induced draught (I.D) fan or both are used the system is called mechanical draught system.

Fans or chimneys produce positive pressure and is called available draught whereas fuel bed resistance, turbulence and friction in air ducts, gas breechings, chimney etc., create negative pressure and is called the required draught.

The various types of draught system are as follows:

- (i) Natural draught
- (ii) Mechanical draught
- (iii) Steam jet draught

### Natural draught



Fig.27 Natural Draught system

Natural draught system is used in boilers of smaller capacities. Natural draught is created by the difference in weight of a column of cold external air and that of a similar column of hot gases in the chimney. This system is dependent upon the height of chimney and average temperature of the gases in the chimney.

Now-a-days the chimney is not used for creating draught in steam power plants as it has no flexibility, the total draught produced is insufficient for high generating capacity.

By using chimney draught can be increased by allowing the flue gases to leave the combustion chamber at higher temperature and this reduced the overall efficiency of the power plant. The chimney is, therefore, used only to discharge the flue gases.

### Mechanical Draught

In boilers of large capacities, fans are employed to create the necessary draught in order to reduce the height of chimney, to obtained draught that is independent of weather conditions and to control the draught easily.

Mechanical draught may be induced forced or balanced draught. Induced draught system shown in Fig. 28(a) is created by chimney and fan located in the gas passage on the chimney side of the boiler. In this system gas movement is achieved as result of vacuum

The various pressures indicated are as follows:

- P1 = Inlet pressure for forced draught fan
- P2 = Outlet pressure of forced draught fan

- P3 =Pressure below grate
- P4 =Pressure above the grate
- P5 =Inlet pressure of induced draught fan
- P6 =Outlet pressure of induced draught fan

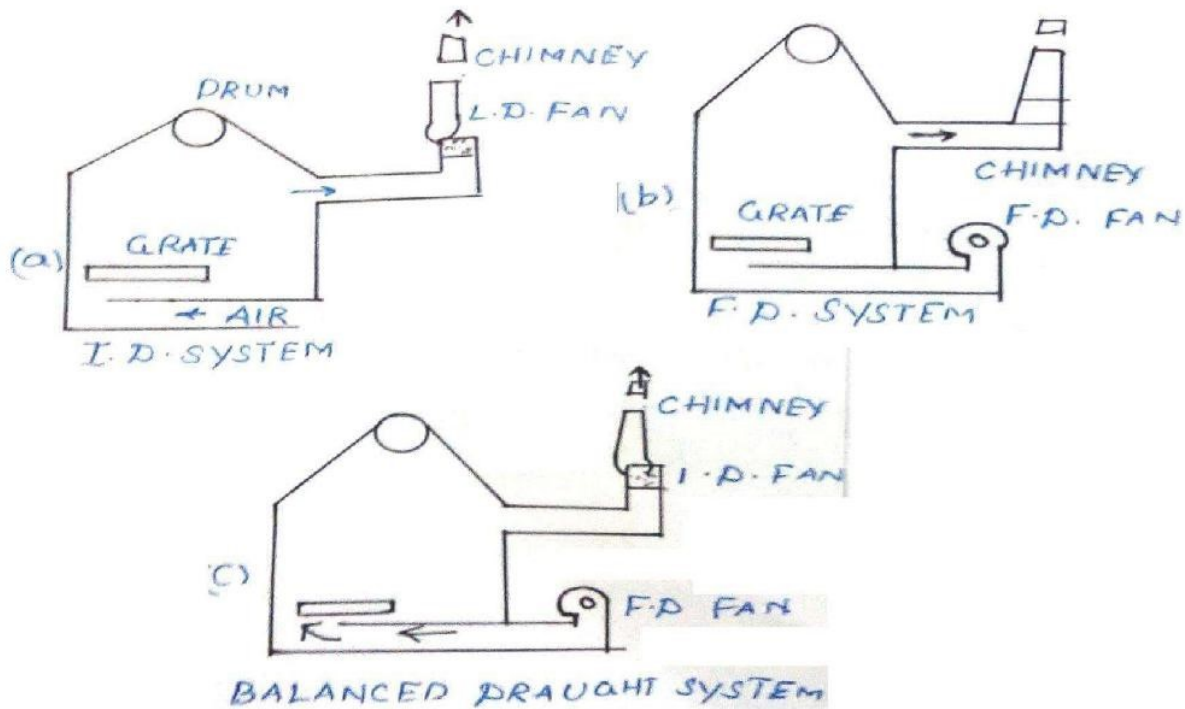

Fig.28 Mechanical draught system

Induced draught is not as simple and direct as forced because fans used in induced draught system operate in gases of much higher temperature (nearly 500°-904°F). Thus becomes more expensive.

The fan sucks in gas from the boiler side and discharges it to the chimney (stack)

The draught produced is independent of the temperature of the hot gases and, therefore, the gases may be discharged as cold as possible after recovering as much heat possible in air preheater and economizer.

In FD system (Fig.28 (b)) the fan installed near the boiler base supplies the air at a pressure above that of atmosphere and delivers it through air duct to the furnace

Most high rating combustion equipment employs forced draught fans for supplying air to the furnace. Forced draught is used in under fed stockers carrying a thick fuel bed. Balanced draught system is a combination of induced and forced draught systems.

The forced draught fan forces the air through the fuel bed on to the top of grate and the induced draught fan sucks in gases from the boiler side and discharges them to the chimney. This system is used where pressure above fire is slightly below atmosphere (Fig.32(c)) shows this system.

### Steam Jet Draught

Steam jet draught may be induced or forced draught depending upon the location of steam jet producing the draught.

Induced draught produced by steam jet as shown in Fig.29. This system is used in locomotive boilers. Exhaust steam from the engine enters the smoke box through a nozzle to create draught. The air is induced through the flues, the grate and ash pit to the smoke box.

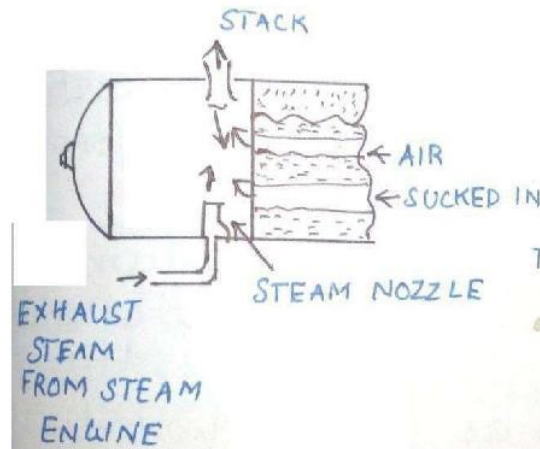

Fig.29 Steam Jet Induced Draught System

Fig.30 shows a forced draught developed by steam jet. Steam from the boiler is passed through a throttle valve, throttle pressure being 1.5 to 2kg/cm<sup>2</sup> gauge.

Then the steam passes through a nozzle projecting in diffuser pipe. The steam comes out of nozzle with great velocity and drags a column of air along with it thus allowing the fresh air to enter.

The mixture of steam and air possesses high kinetic energy and passes through the diffuser pipe. The kinetic energy gets converted into pressure energy and thus air is forced through the coal bed, furnace and flows to the chimney. Steam jet is simple, requires less space and is economical. But it can be used only if steam at high pressure is available.

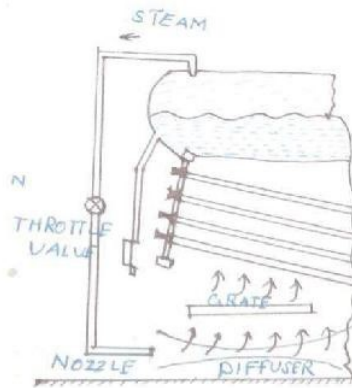

Fig.30 Steam-Jet forced draught system

## FEEDWATER TREATMENT

Boiler make-up water to the extent of 1.5—2 percent of the total flow rate is required to replenish the losses of water through leakage from fittings and bearings, boiler blow down, escape with non-condensable gases in the deaerator, turbine glands, and other causes. This make-up water needs to be treated prior to feeding it to the boiler for

1. Prevention of hard scale formation on the heating surfaces
2. Elimination of corrosion
3. Control of carry-over to eliminate deposition on superheater tubes, and
4. Prevention of silica deposition and corrosion damage to turbine blades.

Raw water is, therefore, first pre-treated and then demineralized. For once through boilers and boiling water nuclear reactors, which require high water purity, a condensate polishing system is used to further polish the water. Raw water contains a variety of impurities, such as (a) Suspended solids and turbidity, (b) organics, (c) hardness (salts of calcium and magnesium), (d) alkalinity (bicarbonates, carbonates, and hydrates), (e) other dissolved ions (sodium, sulphate, chloride, etc.), (f) silica and (g) dissolved gas ( $O_2$ ,  $CO_2$ ). The extent of pre-treatment depends on the source of raw water.

### 1. External treatment

The first step of pre-treatment of boiler feed water is clarification, in which the water is chlorinated to prevent biofouling of the equipment. The suspended solids and turbidity are coagulated by adding special chemicals (like aluminium sulphate,  $Al_2(SO_4)_3$ ) and agitated. The coagulated matter settles at the bottom of the clarifier and is removed.

If the turbidity of clarified effluent is high, positive filtration is needed. Both gravity filters and pressure-type filters are used, but the latter is preferred. A granular medium like sand is commonly used for filtration. The pressure difference across the filtering medium is an indication of solid accumulation. When it reaches a given limit,

the solids are removed from the bed by backwashing. Further filtration by activated carbon can absorb organics and remove residual chlorine from the chlorination process.

The dissolved salts of calcium and magnesium give to water a quality called hardness. Hardness is characterized by the formation of insoluble precipitates or curds with soaps, and is usually measured with a standard soap test. All natural waters are hard and contain scale-forming impurities which are mainly the salts of calcium and magnesium in the form of carbonates, bicarbonates, chlorides and sulphates. The hardness is expressed in ppm of dissolved salts. Softening of water, i.e removal of hardness from water, can be done by lime-soda process, phosphates process, zeolite process and demineralization.

## 2. Lime—soda process

In lime—soda softening, calcium and magnesium salts are removed using lime (calcium hydroxide) and soda ash (sodium carbonate). When this process is carried out at normal raw-water temperature, it is called a “cold process” softening; and when carried out at or near the boiling point, it is referred to as a “hot process” softening. Since heating greatly accelerates the necessary reactions, the hot process is preferred for boiler water treatment, where most of the energy used in heating the water may be retained in the cycle. The representative reactions are given below:

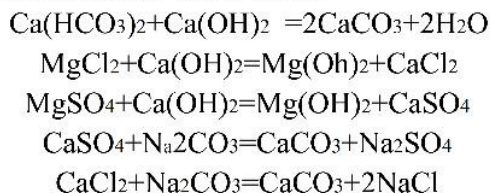

The products, calcium carbonate and magnesium hydroxide are insoluble in water and settle to the bottom of the vessel. The softened effluent is then passed through sand or charcoal filters before usage.

## 3. Hot phosphate Softening

In the hot phosphate softening process, calcium and magnesium hardness is removed using phosphate and caustic soda, Tricalcium phosphate ( $\text{Ca}_3(\text{PO}_4)_2$ ) and magnesium hydroxide are precipitated. The process is carried out at a temperature of  $100^\circ\text{C}$  or above. Since the hot phosphate process requires more expensive chemicals than the lime—soda process, it is used where the initial water hardness is 60 ppm or less. Where hardness is greater than this, a lime soda process may be used first, followed by a phosphate clean-up. The representative reactions are given below:

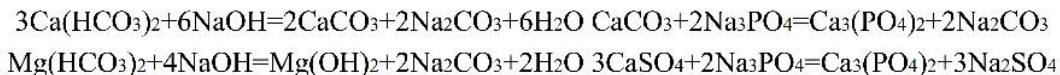

#### 4. Sodium Zeolite Softening

Water can be softened by passing it through a bed of sodium zeolite, which may be natural compounds of sodium aluminium silicate, with the cations of calcium and magnesium removed in the process.

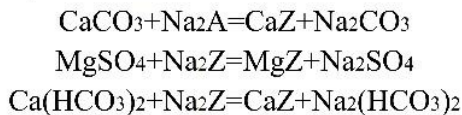

The softening capacity of the bed gets exhausted in course of time, and the bed can be regenerated by flushing it with brine (NaCl),

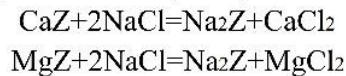

Zeolite softening is not ideal for the following reasons: (i) Water of high or low pH have a deleterious effect on zeolites, (ii) high temperatures also have a bad effect, (iii) turbid waters coat the zeolite material, reducing its efficiency, (iv) there is no reduction in alkalinity or total solids, (v) there can be silica gain in water from the zeolite, (vi) with low content of calcium, the water can be corrosive, sodium zeolite softening in conjunction with the use of evaporating may be more effective.

#### 5. Hydrogen Zeolite softening

When water containing calcium, magnesium and sodium ions is passed through a hydrogen zeolite, these ions are exchanged for hydrogen and the bicarbonate, sulphate, chloride and nitrate radicals are converted to their respective acids. Typical reactions are:

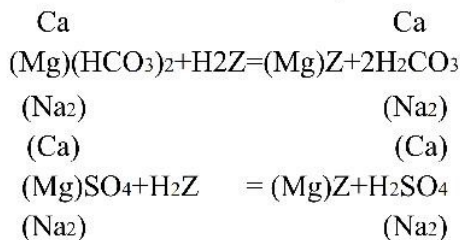

When the hydrogen zeolite becomes exhausted, it is backwashed and regenerated with acid. After being rinsed, it is ready for use again. Sulphuric acid is generally used for regeneration because of its relatively low cost.

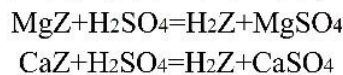

#### 6. Anion exchangers

Anion exchangers can remove the anions like chlorides, sulphates and nitrates (acid forms) present in hydrogen zeolite effluent by resinous materials which absorb them. Typical reactions are:

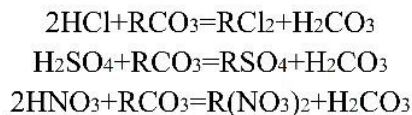

Carbonic acid is removed by aeration. When the acidic water is sprayed in a shower to expose large surface area, the carbon dioxide gas is released.



When the anion exchanger is exhausted, it is regenerated by backwashing with soda ash

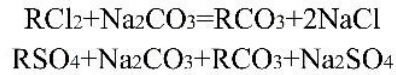

### 7. Demineralizing plant

The process of removing dissolved solids in water by ion exchange is called demineralization. Two types of resins, cation and anion, are used. The cation resin is the hydrogen zeolite where the hydrogen ion is exchanged for the cations calcium, magnesium and sodium, and the anion resin adsorbs the anions chlorides, nitrates and sulphates, as discussed above. Both ion-exchange processes are reversible, and the resins are restored to their original form by regeneration.

A typical Demineralizing plant consisting of a cation exchanger, an anion exchanger, a degasifier and a silica adsorber in series is shown in Fig.31. In the degasifier, carbon dioxide gas is removed by aeration. Silica in water is very detrimental at high pressure. It vaporizes at high pressure and flows with steam, condenses on turbine blades in the form of hard glassy scales which are difficult to remove. Magnesium hydroxide is often used to adsorb silica from water.

The membrane treatment for removing the total dissolved solids from make-up water is also an energy efficient process and is gradually gaining more acceptances. It uses the principle of either reverse osmosis or electro dialysis. The driving force for reverse osmosis is the application of counter pressure to normal osmotic pressure, driving water molecules through the membranes in preference to dissolved salts.

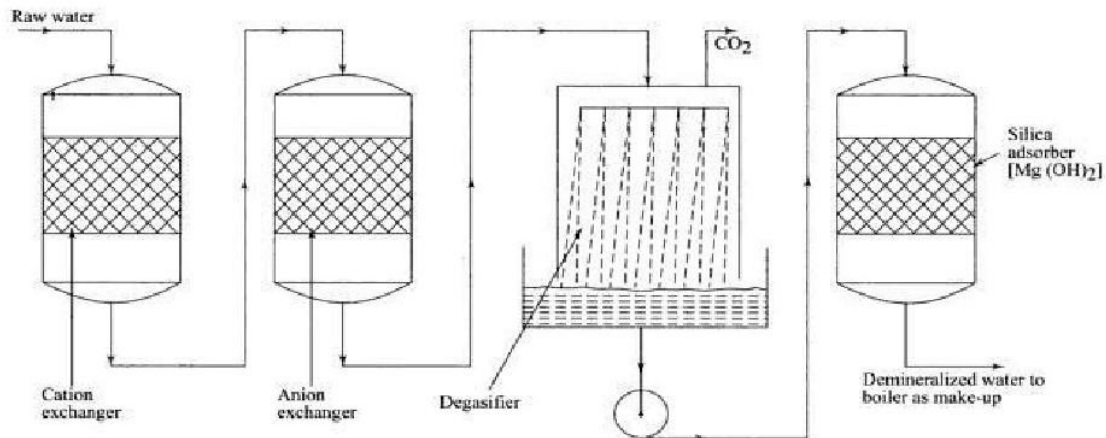

Fig.31 A typical Demineralizing plant

### 8. Condensate polishing

A high quality make-up water can be produced for the plant by using Demineralizing systems as discussed above. However, this treated water while flowing through the cycle can pick up impurities due to condenser leakage from the circulating water through the tubes as well as metallic ions, such as iron and copper, from pipelines.

Condensate polishing is accomplished by passing the condensate through large Demineralizing vessels, called mixed bed units, which contain both cation and anion resins. The resins not only remove dissolved salts in the above manner, but also act as filters for impurities or suspended solids. Power plants using once-through boilers and nuclear reactors generally require high quality water and use condensate polishing systems.

## **BINARY CYCLES**

No single fluid can meet all the requirements as mentioned above. Although in the overall evaluation water is better than any other working fluid, at high temperatures, however, there are a few better fluids and notable among them are :

- (a) Diphenyl ether  $(C_6H_5)_2O$
- (b) Aluminium bromide  $AlBr_3$
- (c) Liquid metals like mercury, sodium, potassium and so on. Among these only mercury has actually been used in practice.

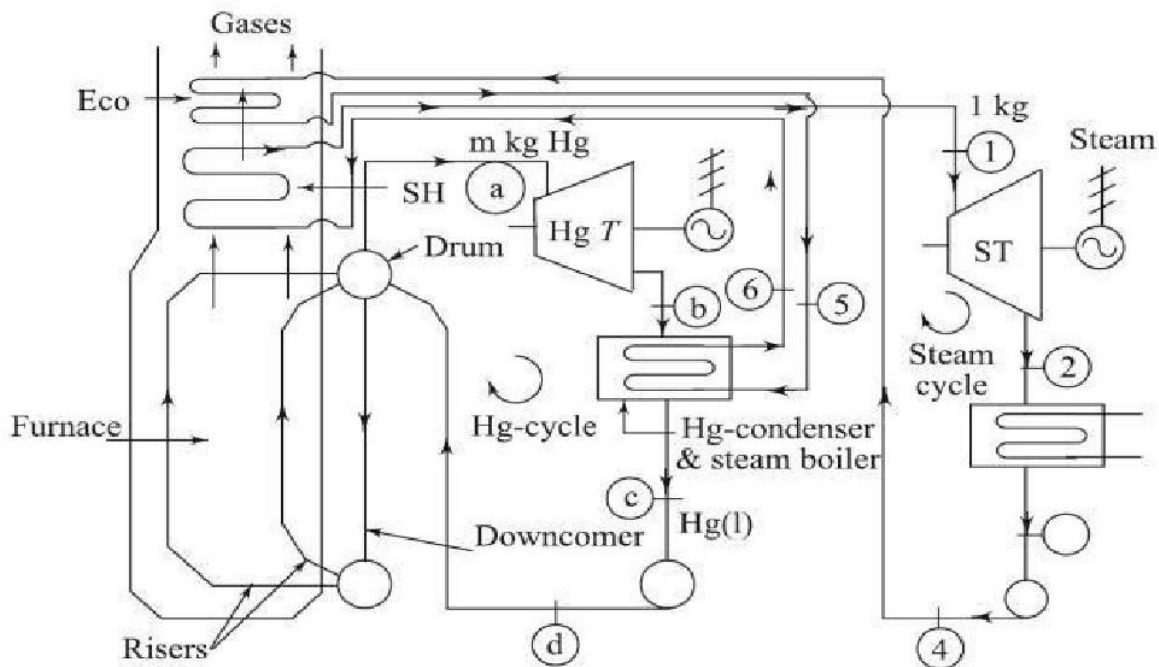

Fig.32 Flow diagram of mercury-steam binary cycle

Diphenyl ether could be considered but it has not yet been used because like most organic substances, it decomposes gradually at high temperatures. Aluminium bromide is a possibility and yet to be considered.

As at pressure of 12 bar, the saturation temperatures for water, aluminium bromide and mercury are 187°C, 482.5°C and 560°C, its vaporization pressure is relatively low. Its critical pressure and temperature are 1080 bar and 1460°C respectively.

But in the low temperature range, mercury is unsuitable because its saturation pressure becomes exceedingly low, and it would be impractical to maintain such a high vacuum in the condenser.

At 30°C the saturation pressure of mercury is only  $2.7 \times 10^{-4}$  cm Hg. Its specific volume at such a low pressure is very large, and it would be difficult to accommodate such a large volume flow.

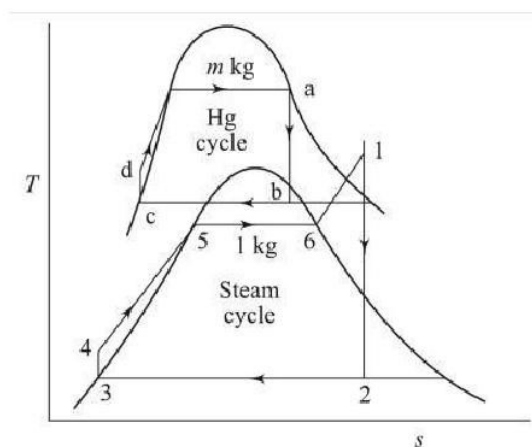

Fig.33 T-S diagram of mercury-steam binary cycle

For this reason, to make advantage of the beneficial features of mercury in the high temperature range and to get rid of its deleterious effects in the low temperature range, mercury vapour leaving the mercury turbine is condensed at a higher temperature and pressure, and the heat released during the condensation of mercury is utilized in evaporating water to form steam to operate on a conventional turbine.

Thus, in the binary (or two fluid) cycle, two cycles with different working fluids are coupled in series, the heat rejected by one being utilized in the other.

The flow diagram of mercury-steam binary cycle and the corresponding T-S diagram are given in Fig.32&33 respectively.

The mercury cycle a-b-c-d is a simple rankine cycle saturated vapour. The heat rejected by mercury during condensation (process b-c) is transferred to boil water and form saturated vapour (process 5-6).

The saturated vapour is heated from the external source (furnace) in the super heater(process 6-1). Super heated steam expands in the turbine and is then condensed. The condensate is then pumped to the economizer where it is heated till it becomes saturated liquid by the outgoing flue gases (process4-5).

The saturated liquid then goes to the mercury condenser-steam boiler , where the latent heat is absorbed. In an actual plant, the steam cycle is always a regenerative cycle with feed water heating, but for the sake of simplicity, this complication has been omitted.

Let m represent the flow rate of mercury in the mercury cycle per kg of steam circulating in the steam cycle. Then , for 1 kg of steam,

$$\begin{aligned}
 Q_1 &= m(h_a-h_d)+(h_1-h_6)+(h_5-h_4) \\
 Q_2 &= h_2-h_3 \\
 W_T &= m(h_a-h_b)+(h_1-h_2) \\
 W_P &= m(h_d-h_c)+(h_4-h_3)
 \end{aligned}
 \left. \vphantom{\begin{aligned} Q_1 \\ Q_2 \\ W_T \\ W_P \end{aligned}} \right\} \text{-----(1)}$$

$$\begin{aligned}
 &= \frac{h_1-h_2}{3892} = \frac{h_1-h_2}{3892} \text{ / k} \\
 (\ ) &= \frac{h_1-h_2}{3892} \text{ / k}
 \end{aligned}$$

The energy balance of the mercury condenser-steam boiler gives

$$m(h_b-h_c) = (h_6-h_5)$$

therefore,

$$= \frac{h_6-h_5}{h_b-h_c}$$

To vaporize one kg of water, 7 to 8 kg of mercury must be mercury.

**COGENERATION SYSTEMS**

There are several industries such as paper mills, textile mills, chemical factories, jute mills, sugar factories, rice mills and so on where saturated steam at the desired temperature is required for heating, drying etc.

For constant temperature heating (or drying), steam is a very good medium since isothermal condition can be maintained by allowing saturated steam to condensate at that temperature and utilizing the latent heat released for heating purposes.

Apart from the process heat, the factory also needs power to drive various machines, for lighting and other purpose.

Earlier, steam of power purposes was generated at a moderate pressure and saturated steam of process work was generated separately at a pressure which gave the desired heating temperature.

Having two separate units for process heat and power is wasteful, for the total heat supplied to the steam generator for power purposes, a greater part will normally be carried away by the cooling water in the condenser.

### Back pressure Turbine

By modifying the initial steam pressure and exhaust pressure, it is possible to generate the required power and make available the required quantity of exhaust steam at the desired temperature for process work.

In Fig.34, the exhaust steam from the turbine is utilized for process heating, the process heater replacing the condenser of the ordinary rankine cycle.

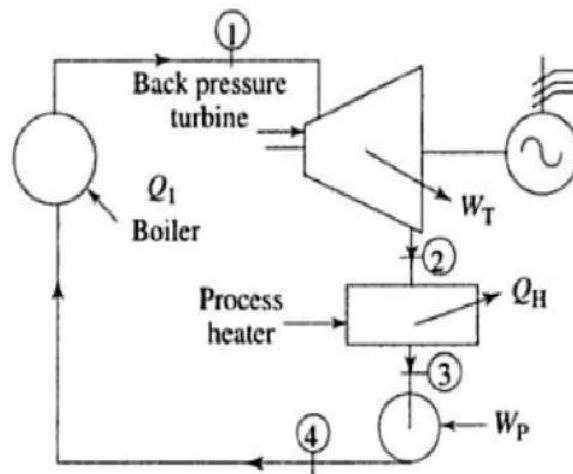

Fig.34 cogeneration plant with a back-pressure turbine

The pressure at exhaust from the turbine is the saturation pressure corresponding to the temperature desired in the process heater such a turbine is called a back pressure turbine.

A plant producing both electrical power and process heat simultaneously is called a **cogeneration plant**.

When the process steam is the basic need, and the power is produced incidentally as a by-product the cycle is often called a byproduct power cycle.

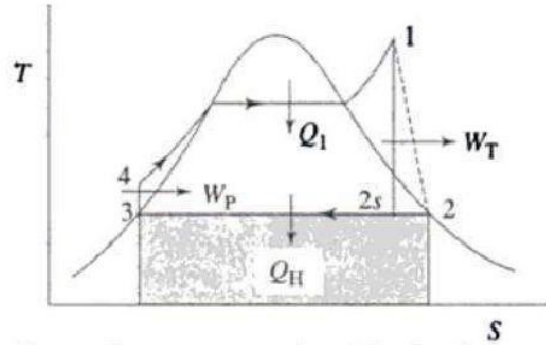

Fig.35 by product power cycle with a back-pressure turbine

Fig.35 shows the T-S plot for such a cycle. If  $W_T$  is the turbine output in kW,  $Q_H$  is the process heat required in kJ/h, and  $w_s$  are the steam flow rate in kg/h.

$$\times 3600 = (h_1 - h_2)$$

$$= (h_2 - h_3)$$

$$\times 3600 = \frac{(h_1 - h_2)}{2} (h_2 - h_3)$$

$$\times 2 = \frac{(h_1 - h_2)}{(h_2 - h_3)}$$

$$(h_1 - h_2)$$

Of the total energy input  $Q_1$  (as heat) to the co-generation plant,  $W_T$  part of it only is converted into shaft work or electricity.

The remaining energy ( $Q_1 - W_T$ ), which would otherwise have been a waste, as in the rankine cycle, by second law, it is utilized as process heat.

The co-generation plant efficiency  $\eta_{co}$  is given by

$$= \frac{W_T + Q_H}{Q_1} \quad (2)$$

For separate generation of electricity and steam, the heat added per unit total energy output is,

$$\frac{1}{\eta_c + e(1 - \eta_c)}$$

Where e = electricity fraction of total energy output

=

$\eta_c$  = electric plant efficiency

$\eta_h$  = steam (or process heat) generator efficiency

The combined efficiency  $\eta_c$  for separate generation is therefore given by

$$\frac{\eta_c + e(1 - \eta_c)}{1}$$

Cogeneration is beneficial if the efficiency of the co-generation plant, equation (2), greater than that of separate generation, equation (3)

Back pressure turbines are quite small with respect to their power output because they have no great volume of exhaust to cope with, the density being high. They are usually single cylinder and hence, cheap in terms of cost per MW compared to condensing sets of the same power.

Besides their use in process industries and petrochemical installations, back pressure turbines are used for desalination of sea-water, district heating, and also for driving compressors and feed pumps.